



POT/I CONVERTER

DIAL INDICATOR INTEGRABLE TYPE

310

FEATURES

- DIAL INDICATOR INTEGRABLE
- 2-WIRE SYSTEM AVAILABLE
- EASY TO ASSEMBLE & WIELD
- WIDTH CALIBRATION RANGE

SPECIFICATIONS

■ CONVERTOR

Output :	4~20 mADC, 2-wire system
Input :	0 to 0.3KΩ ~ 0 to 50KΩ
Accuracy :	± 0.1% F.S. (At 20°C)
Linearity :	± 0.1% F.S.
Burnout Protection :	Upscale ≥ 23mA
Power Supply :	10~30V DC
Load Resistance :	700Ω at 24V DC
Zero Adjuster :	0~25% adjustable by VR
Span Adjuster :	30~100%
Response Time :	0.1 Sec (0~90%)
Isolation :	250 Vrms (Between Input / Output)
Electric Protection :	EEx ia II C T6
Temp. Coefficient :	± 0.02%/°C

■ INDICATOR

Dial :	240° circular arc scale
Scale Length :	136 mm
Input :	4~20 mA DC
Zero Adjuster :	Pointer axis adjustable
Calibration :	Adjuster on Converter
Accuracy :	± 1.0% F.S.
Housing :	ABS resin material Integrated to converter

■ GENERAL

Housing Material :	Aluminium alloy with epoxy resined
Cable Entry :	1/2" NPT (F)
Housing Rating :	EExd IIB T4, IP68
Wiring Terminals :	For wires AWG14~22
Ambient Temp. :	-5 to +60°C, 90% RH max.
Mounting :	Integrated to sensor housing or mounted on 2" stanchion



310A



310B

DIMENSIONS (mm)

■ WITHOUT INDICATOR (310A)

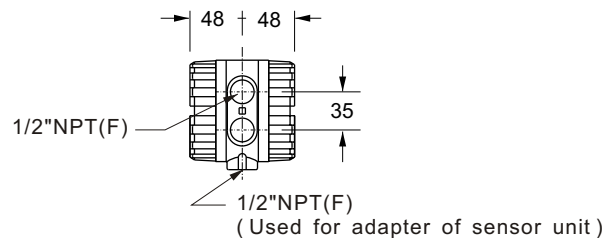

■ WITH INDICATOR (310B)

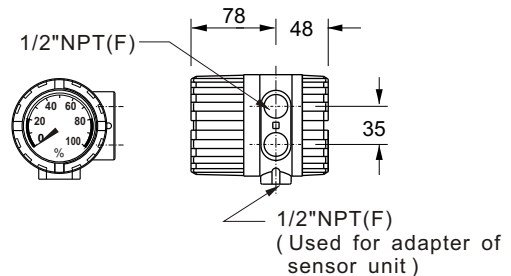

■ MOUNTING ON STANCHION (310 □ -2) (Enclosure with mounting bracket)

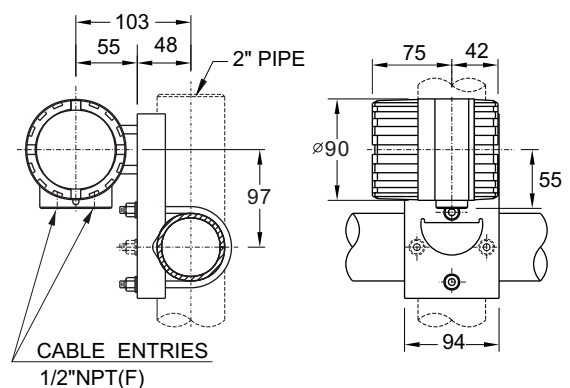

Note: Both indicating meter and mounting bracket of converter can be rotated by 90° and are suitable to be mounted on vertical / horizontal pipes.

MODEL SELECTION

ITEM	CODE	SPECIFICATIONS
① MODEL	310A	No indicating converter
	310B	Indicating Converter
	310C	OEM Versions
② MOUNTING	—0	Combine to external housing (Moulding enclosed only)
	—1	Keep 1/2"NPT(F) of connection assembled with converter
	—2	Mounted on 2" stanchion
	—3	To be specified
③ INPUT	01	0~1KΩ
	50	0~50KΩ
	00	To be specified
④ OUTPUT	—A	4~20 mA DC (2-wire system)
	—B	To be specified
⑤ CABLE ENTRY	A	Not provided (With terminal board)
	B	1/2" NPT (F)
	C	To be specified
⑥ HOUSING RATING	A	Inner housing enclosure only
	B	IP67
	C	EEExd IIB T4, IP67

WIRING CONNECTIONS

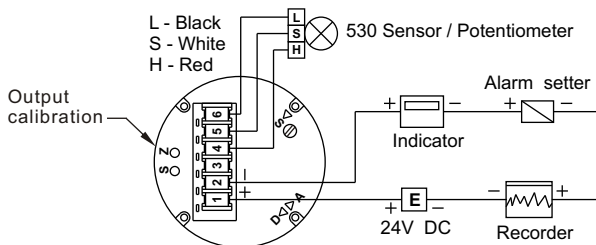

NOTE : When the direction of sensor tube is upside down, the sensor wiring terminals L/H should be reversed as well.

CALIBRATION

■ 310A (WITHOUT INDICATOR)

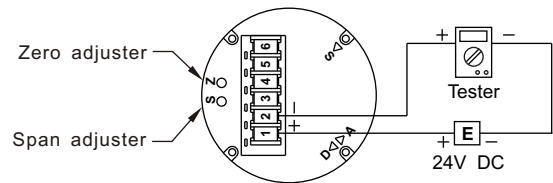

WHEN CORRECTING THE OUTPUT SIGNAL:

1. Turn on the cover of housing.
2. Remove the number first and second of loop wiring from the terminal board.
3. Connect the power and ammeter (or generator of signal).
4. Use Zero /span adjuster to set value.
5. After received correct signal, use reverse step to get back to the original.

■ 310B (WITH INDICATOR)

□ OUTPUT CALIBRATION

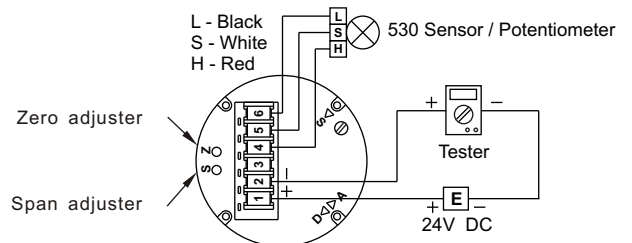

□ INDICATOR CALIBRATION

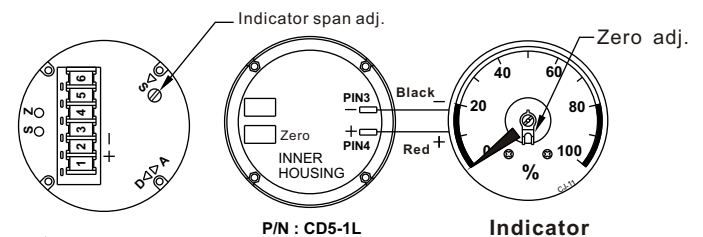

⚠ CAUTION :

Before calibrating, should check other related devices whether or not to carry-on above - mentioned correcting procedure, especially at the danger / explosion - proof area at the system operating.

The specifications are subject to change without prior notice.

2K710-A1

DOERS TECHNOLOGY CORPORATION

4F, NO. 1, LANE 11, TZU CHIANG STREET, TU-CHENG INDUSTRIAL PARK, TAIPEI COUNTY, TAIWAN 23678

Website : www.doers.com.tw

E-mail: doers.tech@msa.hinet.net

TEL : 886-2-22682689

FAX : 886-2-22681248

